

SURFACE MOUNT LED EXIT SIGN

EMERGENCY BATTERY BACKUP

INSTALLATION & OPERATION INSTRUCTIONS

Package Contents

Part	Description	Quantity
1	LED Edge-Lit EXIT Sign	1
2	Canopy	1
3	Hardware Bag	1

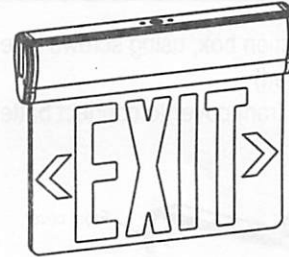

Warnings and Cautions

IMPORTANT SAFEGUARDS

READ AND FOLLOW ALL SAFETY INSTRUCTIONS.

1. Review the diagrams thoroughly before beginning. If you feel you do not have electrical wiring experience, refer to a do-it-yourself wiring handbook or have your fixture installed by a qualified licensed electrician.
2. All electrical connections must be in accordance with local codes, ordinances, and the National Electric Code. If you are unfamiliar with methods from installing electrical wiring, secure the services from a qualified licensed electrician.
3. Before starting the installation, disconnect the power by turning off the circuit breaker or by removing the appropriate fuse at the fuse box. Using the light switch to turning the power off is not sufficient to prevent electrical shock.
4. Do not use outdoors.
5. Do not let power supply cords touch hot surfaces.
6. Do not mount near gas or electric heaters.
7. Use caution when servicing batteries. Battery acid can cause burns to skin and eyes. If acid is spilled on skin or eyes, flush acid with fresh water and contact a physician immediately.
8. Equipment should be mounted in locations and at heights where it will not be subjected to tampering by unauthorized personnel.
9. The use of accessory equipment not recommended by the manufacturer may cause an unsafe condition.
10. Do not use this equipment for other than its intended use.
11. All servicings should be performed by a qualified personnel only.
12. Allow battery to charge for 24 hours before first use.

SAVE THESE INSTRUCTIONS

ELECTRICAL CONNECTIONS

- Make the proper supply wire connections.
- If using 120VAC, connect the black and white wires to the building utility.
- If using 277VAC, connect the orange and white wires to the building utility.
- Cap off unused wires. In all cases, use standard wire nuts to connection to wires.

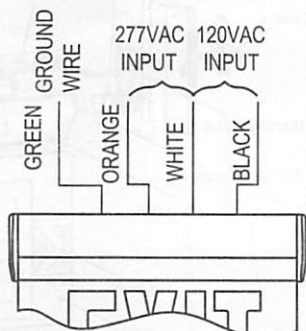

DETERMINE DIRECTION

- If need indicator, remain indicator and remove instruction film.
- If no need indicator, remove indicator and instruction film together.



Mounting Instructions

NOTE: First turn off electricity.

Surface Ceiling & Wall Mounting

1. Attach crossbar to junction box, using screws if needed. (screws are not provided)
2. Use screwdriver open front cover to connect battery connector.

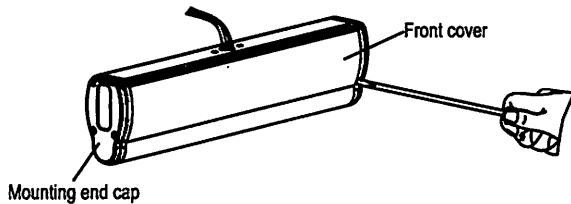

3. Feed AC supply wires through canopy center hole.
4. Assemble canopy onto main body assembly with (2) PM4*15 screws (supplied) and make proper wire connections. (See ELECTRICAL CONNECTIONS).
5. Use (2) PM4*40 screws (supplied) tighten canopy to crossbar.

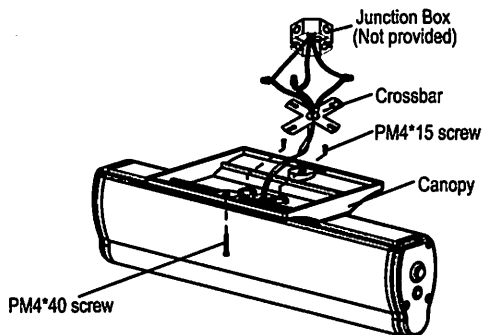

6. Insert EXIT panel into main body assembly gently. If EXIT panel is for single face, make sure EXIT letter direction is right.

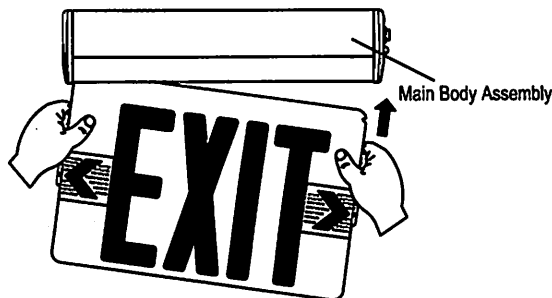

7. Determine direction for chevron placement. (See DETERMINE DIRECTION)

8. The unit can be installed on any surface, you may rotate the EXIT panel in any angle from 0° to 180°. Ceiling mounting rotate 90° become Wall mounting.

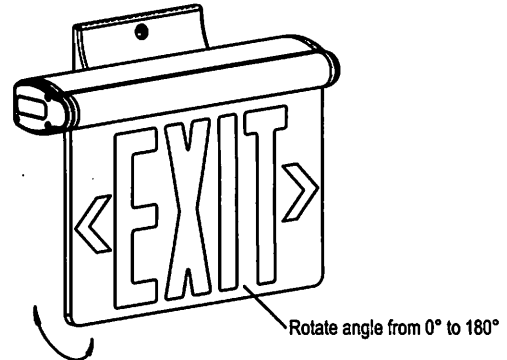

Surface End Mounting

1. Attach crossbar to junction box, using screws if needed. (screws are not provided)
2. Use screwdriver open front cover to connect battery connector.
3. Remove the hole plug from mounting end cap.
4. Pull out all AC supply wires and feed wires thru the center holes of mounting end cap and then canopy.
5. Reference 4 - 7 step in surface ceiling & wall mounting above for surface end mounting.

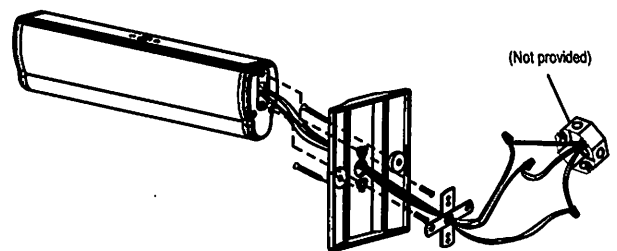

6. The unit can be installed on any surface, you may rotate the EXIT panel in any angle from 0° to 180°.

Assembly Drawing

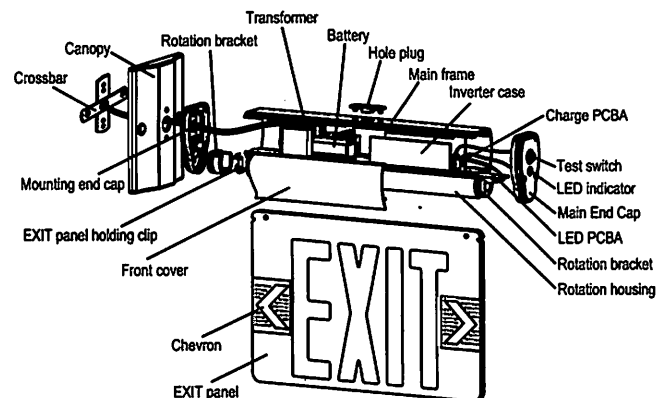

1. Install Emergency Lighting according to Installation Instruction sheet.

2. As soon as AC power is supplied to fixture, the unit will automatically initiate a self-test and self-diagnostic Test as follows:

- (1) Verifies battery disconnection, charger board failure, lamps failure and transformer failure at every 5 seconds.
- (2) One-minute self-testing every month.
- (3) 30 minutes self-testing on the 6th month of the year after installation.
- (4) 90 minutes self-testing on the 12th month of the year after installation.
- (5) Factory pre-set all functions-Do not need field adjustment.

3. Dual color LED lamp indicator shows the following status:

- (1) Green color

	ON/ Ready
	Blinking: Testing
- (2) Red color (Service Alert)
- (3) Service Alert LED Code (Red color LED lamp indicator)

●	One blink ON/pause (4 seconds)	Battery is not connected
●●	Two blinks ON/pause (4 seconds)	Battery is shorted or battery voltage drops below than acceptable value
●●●	Three blinks ON/pause (4 seconds)	Charger board fault
●●●●	Four blinks ON/pause (4 seconds)	Transformer fault
●●●●●●●●	Seven blinks ON/pause (4 seconds)	EXIT LED strip fault

CAUTION:

After solve the fault of emergency equipment, please press test button for 2 second without release, then LED indicator will show Green color.

4. For manual test, press test button as follows:

Press test button once	(within 2 seconds)	1 minute test
Press test button twice	(within 2 seconds)	5 minutes test
Press test button 3 times	(within 2 seconds)	30 minutes test
Press test button 4 times	(within 2 seconds)	90 minutes test

Recessed Kit Assemble Instructions

The following steps will guide you on how to convert your edge lit exit sign into a recessed exit sign.

These steps apply to the following exit signs:

ELRT-R, ELRTR-R, ELRT-G, ELRTR-G, NYCELRT, and NYCELRTR

(Tools Needed: Phillips Screwdriver)



1)

You may begin by removing the 3 philips screws from the cover with the AC light and the test button. This will give you access to the AC light, test button, and wires.



2)

Once all 3 screws are removed, you may proceed separating the cover. Make sure not to pull too far as the AC light and test button are still connected to the circuit board.



3)

With the cover separated from the housing, you can now proceed with removing the AC light and the test button. The test button can be removed by disconnecting the 2 white connectors and removing the hex-nut.



4)

The AC light will come off by pushing the light inward using small force. With the AC light, off, you may remove the AC light holder as you will need it when reinstalling the AC light.



5)

With the AC light holder off and the test button removed, you may feed the AC light and the test button connector through their respective holes. Once this is complete, you may now put the cover back in place and line it up with the housing and screw the cover back in place.



6)

With the cover back in place, you can now proceed with placing the housing inside the recess kit. The AC light and test button connector should look like the image to the left.

Recessed Kit Assemble Instructions



7) The recessed kit plate has two holes. One for the AC light and one for the test button. You will insert the AC light connector to its respective hole and the test button to its respective hole.

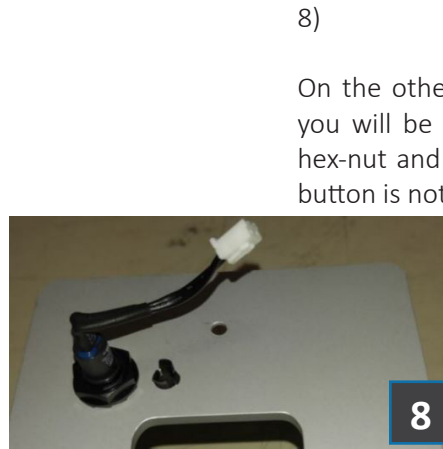

8) On the other side of the plate, you will be able to tighten the hex-nut and make sure the test button is not loose and assure it will not move.



9) Once the test button and the AC light holder are in place, you may now proceed with connecting the test button and placing the AC light into its holder like the image on the left.



10) Once the AC light and test button connectors are in place, you may proceed with placing the plate to the recess kit housing. Align the holes from the plate to the recess kit housing and screw the two philips screws back in place.

With everything in place, the recessed kit should look like the image below. Please note that if the angle of the exit sign panel needs to be adjusted, it will need to be adjusted before placing the recess kit plate back to the recess kit housing.

